

## WQV

Vortex cutting submersible pump  
Vórtice bomba sumergible de corte  
Pompe submersible de coupe Vortex



### NEW/NUEVO/NOUVEAU

#### DESCRIPTION/DESCRIPCIONES/DESCRIPTION

- ◆ New cutting submersible sewage pumps design
  - ◆ Equipped with vortex alloy impeller with 48HR(hardness)
  - ◆ Better hydraulic characteristics
  - ◆ Pump case in heavy gauge robust cast iron HT250
  - ◆ Casing resistant to abrasion and long-lasting
  - ◆ Discharge port with bolts,nuts and gaskets
  - ◆ Quality NSK bearing, wear resistance mechanical seal
- ◆ Nuevo diseño de bombas sumergibles corte para aguas residuales
  - ◆ Equipado con impulsor de aleación vortex con 48HR (dureza)
  - ◆ Mejores características hidráulicas
  - ◆ Caja de bomba en hierro fundido robusto de gran calibre HT250
  - ◆ Carcasa resistente a la abrasión y duradera.
  - ◆ Puerto de descarga con pernos, tuercas y empalmes
  - ◆ Rodamiento de marca NSK y cierre mecánico personalizado
- ◆ Nouvelle conception de pompes submersibles coupe pour eaux usées
  - ◆ Équipé d'une roue en alliage vortex avec 48HR (dureté)
  - ◆ Meilleures caractéristiques hydrauliques
  - ◆ Carter de pompe en fonte robuste de fort calibre HT250
  - ◆ Boîtier résistant à l'abrasion et durable
  - ◆ Orifice de décharge avec boulons, écrous et joints
  - ◆ Roulement NSK qualité, joint mécanique de résistance à l'usure

#### USING LIMITS/LÍMITES UTILIZACIÓN/UTILISATION LIMITES

- ◆ Temperature of the liquid to +40 °C
  - ◆ 10m maximum immersion depth
  - ◆ Solids passage: from 25mm to 65mm
- ◆ Temperatura del líquido a +40 °C
  - ◆ 10m de profundidad de inmersión máxima
  - ◆ Paso de sólidos: de 25 mm a 65 mm
- ◆ Température du liquide à +40 °C
  - ◆ Profondeur d'immersion maximale de 10m
  - ◆ Passage des solides: de 25 mm à 65 mm

#### MODEL CODE/CÓDIGO MODELO/CODE MODÈLE

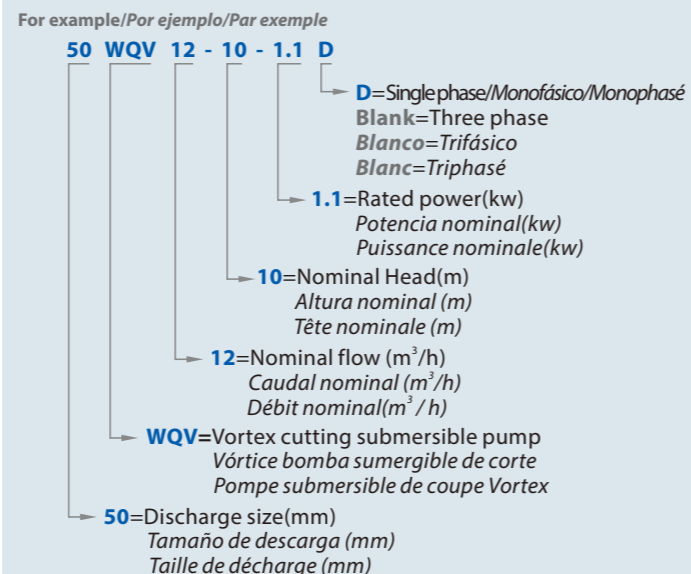

#### TECHNICAL DATA/DATOS TÉCNICOS/DONNÉES TECHNIQUES

50 Hz n=2900/1450 1/min

MODEL/MODELO/MODÈLE		Power Potencia/Puissance		Rated Q	Rated H	RPM	DN	KGS	DIM
Single-phase Monofásico/Monophasé	Three-phase Trifásico/Triphasé	hp	kw	m <sup>3</sup> /h	m		mm		cm
40WQV10-10-0.75D	40WQV10-10-0.75	1	0.75	10	10	2900	40	22.5	48*20*22
40WQV12-10-1.1D	40WQV12-10-1.1	1.5	1.1	12	10	2900	40	23.7	48*20*22
50WQV10-10-0.75D	50WQV10-10-0.75	1	0.75	10	10	2900	50	22.5	48*20*22
50WQV12-10-1.1D	50WQV12-10-1.1	1.5	1.1	12	10	2900	50	23.7	48*20*22
50WQV15-15-1.5D	50WQV15-15-1.5	2	1.5	15	15	2900	50	36.5	60*27*25
-	50WQV9-22-2.2	3	2.2	9	22	2900	50	40.1	61*29*29
-	65WQV25-15-2.2	3	2.2	25	15	2900	65	41.4	61*29*29
-	80WQV45-9-2.2	3	2.2	45	9	2900	80	43.4	61*29*29
-	50WQV20-22-3	4	3	20	22	2900	50	45.8	63*26*30
-	65WQV35-15-3	4	3	35	15	2900	65	46.6	63*26*30
-	80WQV43-13-3	4	3	43	13	2900	80	47.4	63*26*30
-	65WQV25-22-4	5.5	4	25	22	2900	65	52.2	64*29*32
-	80WQV45-17-4	5.5	4	45	17	2900	80	52.9	64*29*32
-	80WQV30-25-4	5.5	4	30	25	2900	80	53.5	64*29*32
-	80WQV45-20-5.5	7.5	5.5	45	20	2900	80	62.5	73*29*34
-	100WQV65-15-5.5	7.5	5.5	65	15	2900	100	63.6	73*29*34
-	80WQV45-22-7.5	10	7.5	45	22	2900	80	72	73*31*35
-	100WQV100-13-7.5	10	7.5	100	13	2900	100	73.5	73*31*35
-	100WQV80-25-11	15	11	80	25	1450	100	187	96*53*44
-	150WQV150-15-11	15	11	150	15	1450	150	201	101*52*42
-	100WQV80-30-15	20	15	80	30	1450	100	208	100*53*44
-	150WQV200-15-15	20	15	200	15	1450	150	222	105*52*42
-	150WQV250-15-18.5	25	18.5	250	15	1450	150	286	115*57*44
-	200WQV350-12-18.5	25	18.5	350	12	1450	200	294	120*58*46
-	150WQV300-15-22	30	22	300	15	1450	150	307	125*57*44
-	200WQV400-10-22	30	22	400	10	1450	200	324	120*58*46
-	200WQV350-15-30	40	30	350	15	1450	200	440	135*57*67
-	250WQV600-10-30	40	30	600	10	1450	250	440	140*60*67

#### IMPELLER TYPE/TIPO DE IMPULSOR/TYPE ROUE

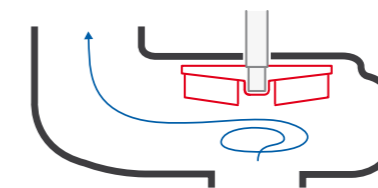

VORTEX

MATERIAL DESCRIPTION/DESCRIPCIÓN DE MATERIAL/DESCRIPTION DU MATÉRIEL

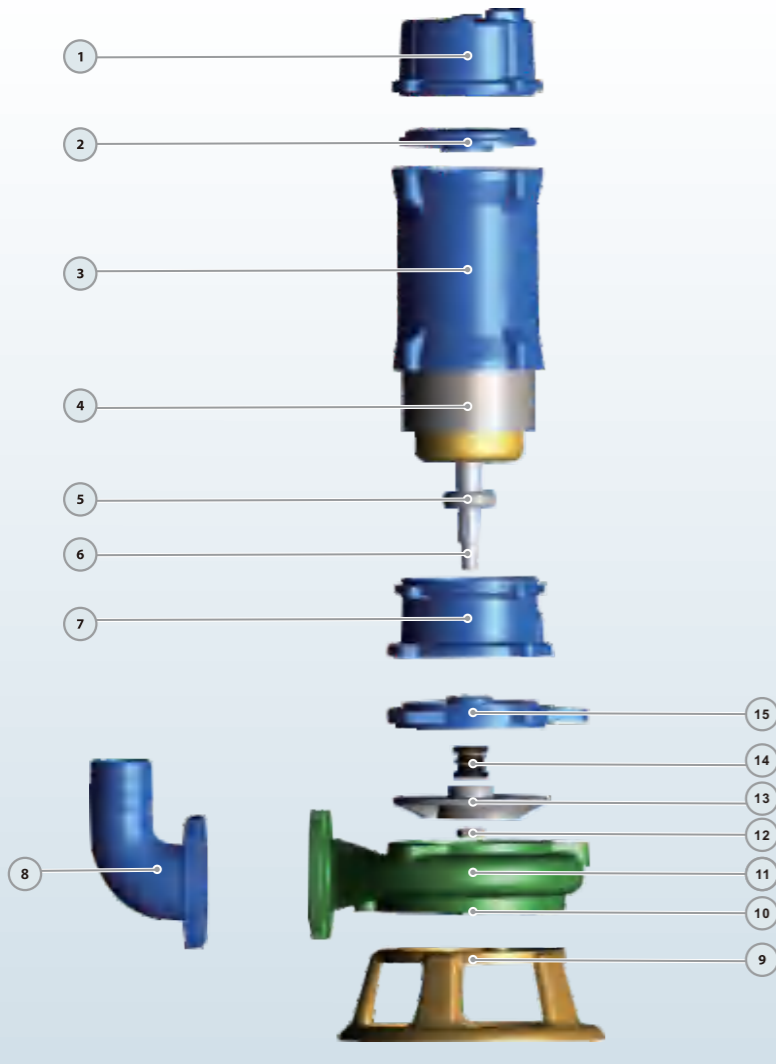

No.	Description Descripción Description	Material Material Matériel
1	Motor cover Tapa de motor Capot moteur	Cast iron Fundición Fonte
2	Plate Plato Assiette	Cast iron Fundición Fonte
3	Motor Case Cuerpo de Motor Boîtier du moteur	Cast iron Fundición Fonte
4	Wound Stator/Rotor Estator/Rotor Stator/Rotor de blessure	Silicon Steel/Copper Silicio-Cobre Silicium-Cuivre
5	Bearing Rodamiento Palier	Ball Bearing Bola Rodamiento Palier Balle
6	Shaft Eje Arbre	SS304-45# Steel Inox 304/Hierro Inox304-Acier
7	Chamber Sala Chambre	Cast iron Fundición Fonte
8	Output flange Brida de salida Bride de sortie	Cast iron Fundición Fonte
9	Base Base Base	Cast iron Fundición Fonte
10	Cutter plate Placa de corte Plaque de coupe	Alloy 48HR Aleación 48HR Alliage 48HR
11	Pump Case Cuerpo de Bomba Boîtier de pompe	Cast iron Fundición Fonte
12	Impeller Nut Nuez Noix	Galvanized Steel Acero Galvanizado Acier Galvanisé
13	Impeller Impulsor Roue	Alloy 48HR Aleación 48HR Alliage 48HR
14	Mechanical Seal Cierre Mecánico Sceller	SiC/Carbon/SS304 SiC/Grafito/Inox304 SiC/Carbon/Inox304
15	Seal plate Plato sello Plaque d'étanchéité	Cast iron Fundición Fonte

PERFORMANCE CURVE/CURVA DE RENDIMIENTO/COURBE DE PERFORMANCE

50 Hz n=2900 1/min

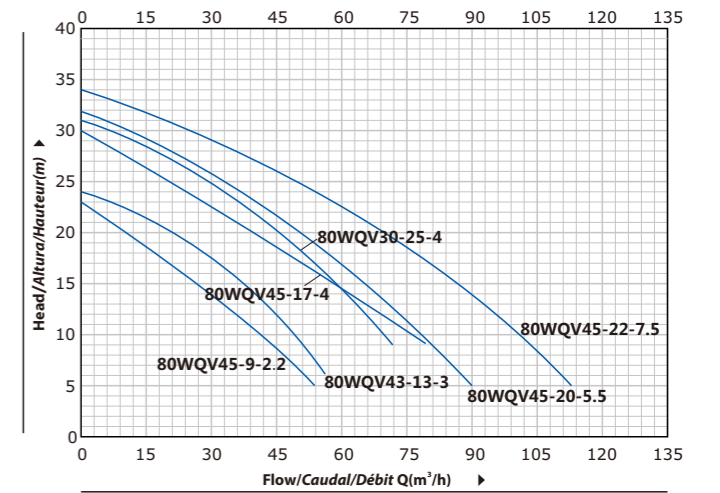
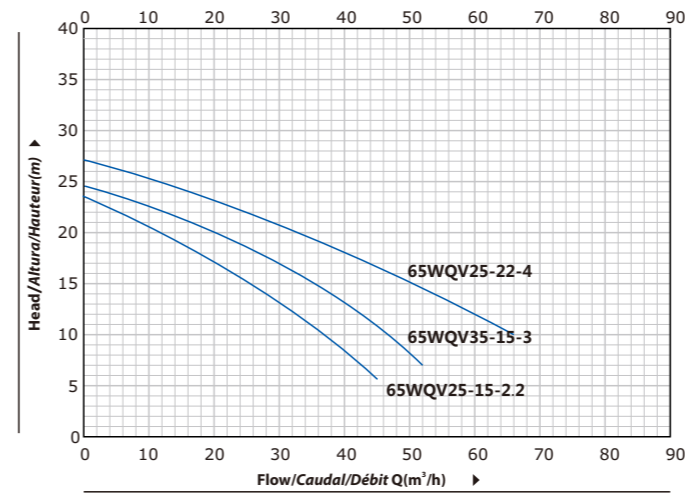

50 Hz n=2900/1450 1/min

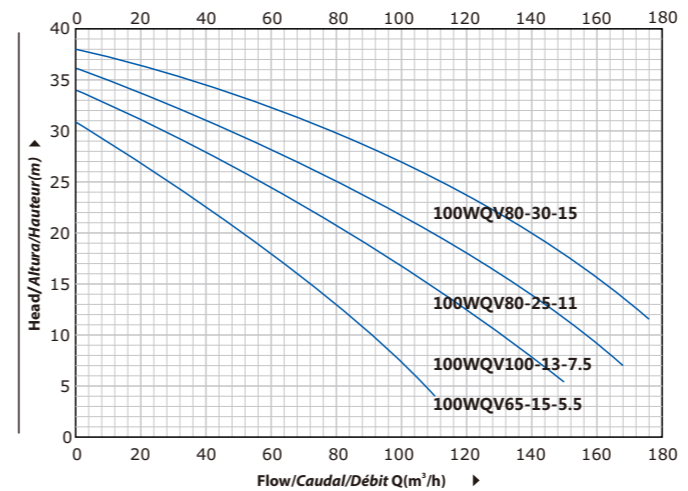

50 Hz n=1450 1/min

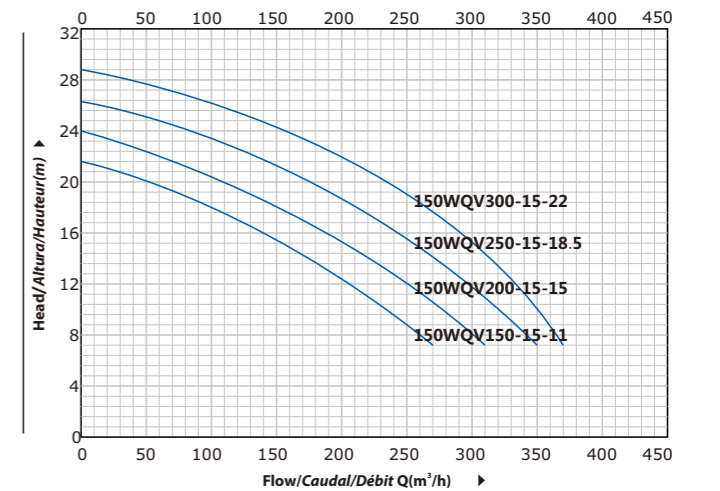

PERFORMANCE CURVE/CURVA DE RENDIMIENTO/COURBE DE PERFORMANCE

50 Hz n=2900 1/min

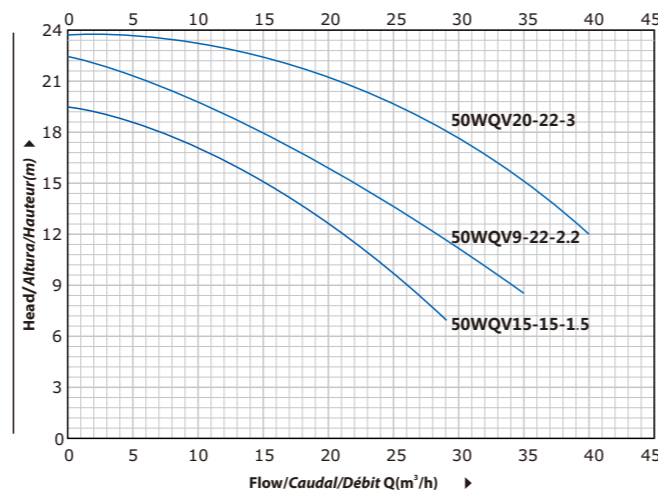
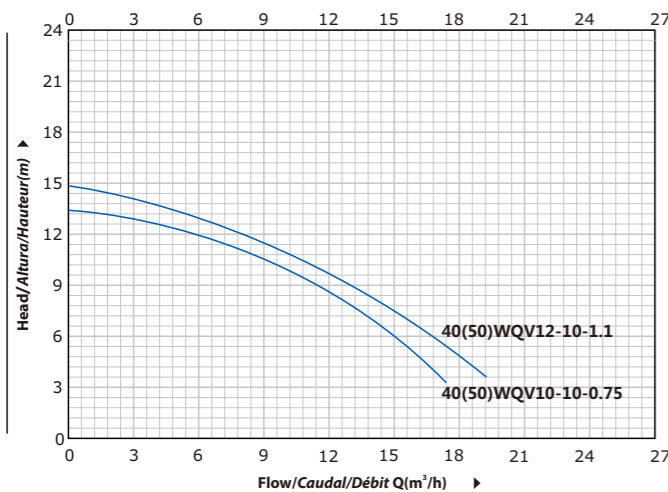

50 Hz n=1450 1/min

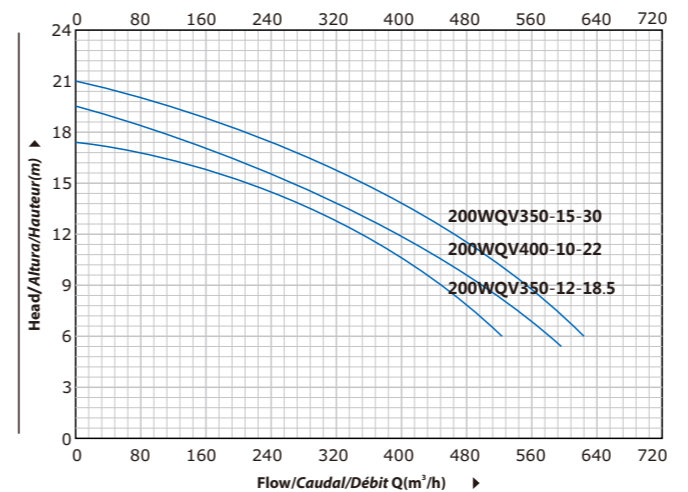

50 Hz n=1450 1/min

